

# CCS Technical Documentation

## RH-40 Series Transceivers

# Service Tools



**Contents**

	<b>Page No</b>
Service Tools.....	5
2220 .....	5
Flashing and Testing Setups .....	11
POS Flash Setup 1 .....	11
Flashing, testing, and tuning with covers on (Setups 2a, 2b, 2c, 2d) .....	12
Service Setup 2a .....	13
Service Setup 2b .....	14
Service Setup 2c .....	15
Service Setup 2d .....	16



## Service Tools

2220

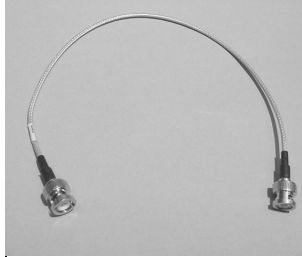



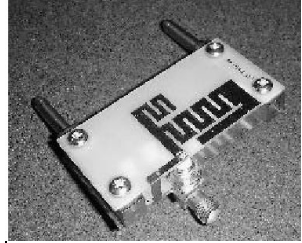
Photo	Code	Service Tool	Code	Description Info
	ADS-3	Audio Cable	0730197	The Audio Cable connects to the Audio Box JBA-6.
	ADS-4	Audio Cable	0730222	The Service Cable connects the phone and the Service Audio Box.
	AXP-8	Printer Cable	073F000	The Parallel Printer Cable connects the parallel connector of the PC and the parallel input of the FPS-8.
	AXS-4	D9-D9 Cable	0730090	The D9-D9 cable AXS-4 is used to connect two 9 pin D connectors (for example, between a PC and TDF-4 security box).
	CPL-1	Coupler	0770287	The Coupler has been developed for antennas' go/no go testing. <i>Note: Tuning is not allowed with the CPL-1.</i>





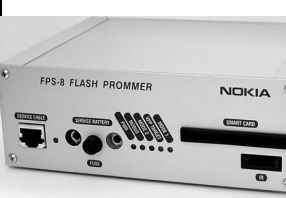
Photo	Code	Service Tool	Code	Description Info
	DAU-9S	MBUS Cable	0730108	The MBUS Cable DAU-9S has a modular connector, and is used with the service Audio Box JBA-4 or a modular T-adapter.
	DDC-1	Power Pack	0670405	The Power Pack provides the phone with power via FLA-39. The phone's own battery can be used in DDC-1. <i>Note: DDC-1 allows battery charging. When it is used as a charger, the power pack need to be disconnected.</i> <i>Note: When DDC-1 is used as a Power Pack, battery charging is not allowed!</i>
	FLA-39	Flash Adapter	0770490	The flash adapter allows FBUS/MBUS connections for flashing.
	FLS-4S	POS Flash Adapter	0080543	The Point of Sale (POS) flash is a low-cost software upgrade tool. This requires the XCS-1 cable and ACP-8U for operation.
	FPS-8	Flash Prommer	0080321	The Flash Prommer FPS-8 is used for heavy flash.

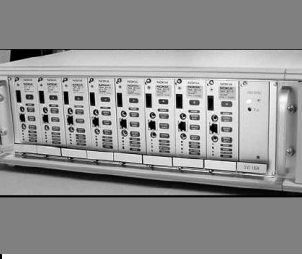



Photo	Code	Service Tool	Code	Description Info
	FPS-8C	Heavy Flash Prommer	0080396	The FPS-8C is used for heavy flashing.
	GAC-1	Galvanic Connector	0770301	The GAC-1 adapter is needed for the RF connection. The GAC-1 adapter makes galvanic connections to assembled handset RF-switches possible. Via this adapter, the handset is connected to the RF measuring and test equipment.
	JBA-8	Audio Box	0770320	The Audio Box is needed for audio connections. The box must support DCT4 Janette audios. The Service Audio box provides an interconnection between the phone's system connector (XEAR, XMIC) through a fixed audio cable and Audio tester with a BNC-BNC coax. The connection to a PC can be made with the service battery, through a DAU-9 cable. The Service Audio Box JBA-8 is used for service purposes.
	JBV-1	Docking Station	0770298	The Docking Station and the Docking Station Adapter (MJF-23) are needed for Mbus, Fbus, RF, and audio connections. This setup allows connection between flash prommers. When the audio box is connected, it has to be connected to the phone's audio connector. The Docking Station can be powered by FPS-8 or external power supply.


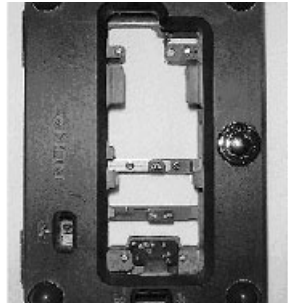
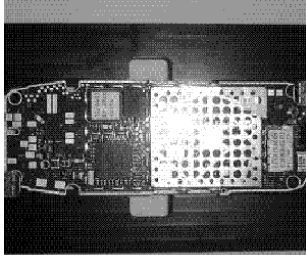

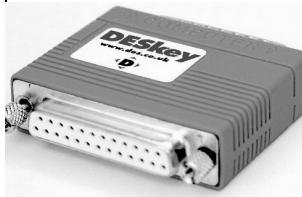



Photo	Code	Service Tool	Code	Description Info
	MJF-23	Docking Station Adapter	0770489	The Docking Station Adapter, together with the Docking Station (JBV-1), are needed for Mbus, Fbus, RF, and audio connections. This setup allows connection between flash promoters. When the audio box is connected, it has to be connected to the phone's audio connector. The Docking Station can be powered by FPS-8 or external power supply.
	MJS-18	Module Jig	0770299	This jig allow phone PWB-level service and troubleshooting. Electric circuits have to be protected against over-voltage and over-current.
	MJS-27	Soldering Jig	0775287	This jig allows phone PWB level service and troubleshooting for authorized service centers.
	PCS-1	Power Cable	0730012	The Power Cable PCS-1 is used to connect the service tools (JBV-1, MJS-57) to an external power supply.

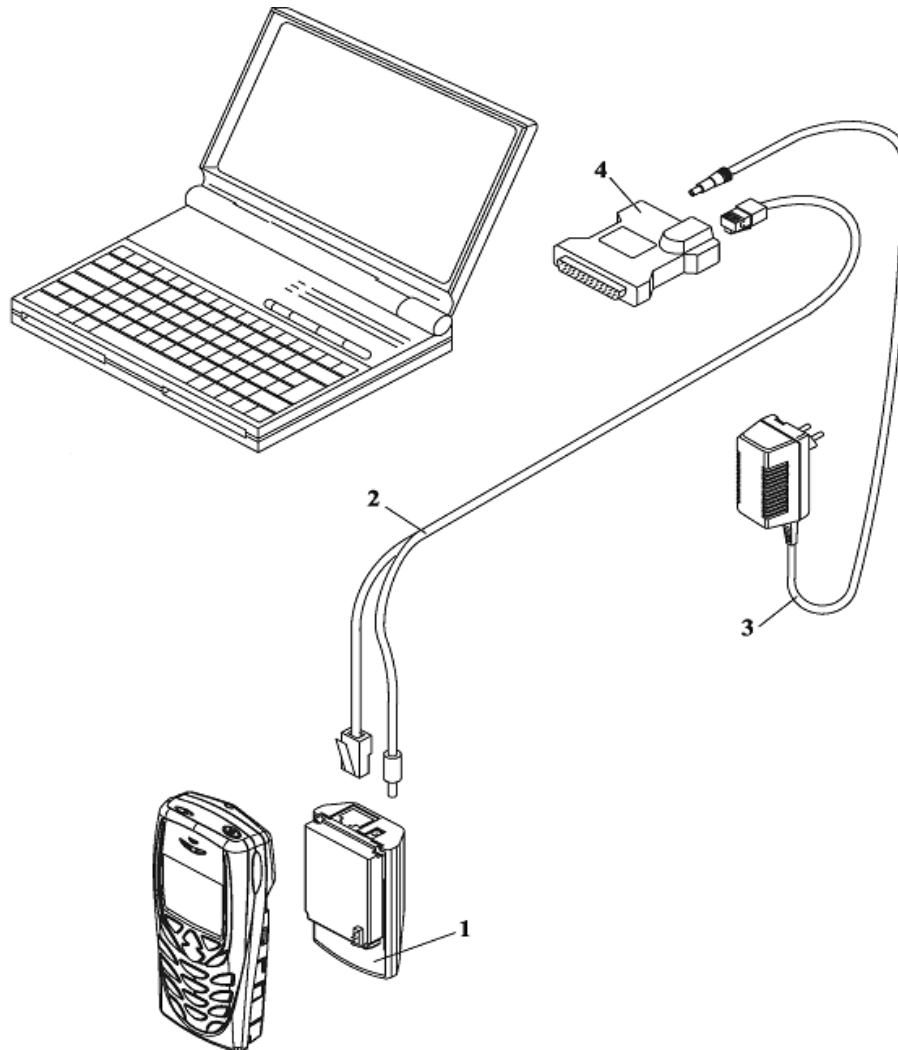


Photo	Code	Service Tool	Code	Description Info
	PKD-1	SW Security Device	0750018	<p>SW security device PKD-1 is hardware device that, when connected to the parallel (LPT) port of the PC, enables the use of the service software. Without the dongle present, it is not possible to use the service software. Printers or other peripheral devices can be connected to the PC through the dongle, if needed.</p> <p><i>Caution: Make sure that you have switched off the PC and the printer before making connections!</i></p> <p><i>Caution: Do not connect the PKD-1 to the serial port. You may damage your PKD-1!</i></p>
	SCB-3	DC Cable	0730114	The DC Cable SCB-3 is used to connect the docking station to the charger connection (Vin) of the phone to conduct the charger calibration service procedure.
	XCS-4	Mbus/Fbus Cable	0730178	The XCS-4 Service Cable is a modular cable for flashing DCT4 products.
	XRF-1	RF Cable	0730085	RF Cable XRF-1 is used to connect the service tools to RF measuring equipment.

## Flashing and Testing Setups

### POS Flash Setup 1

Figure 1: View of POS flash



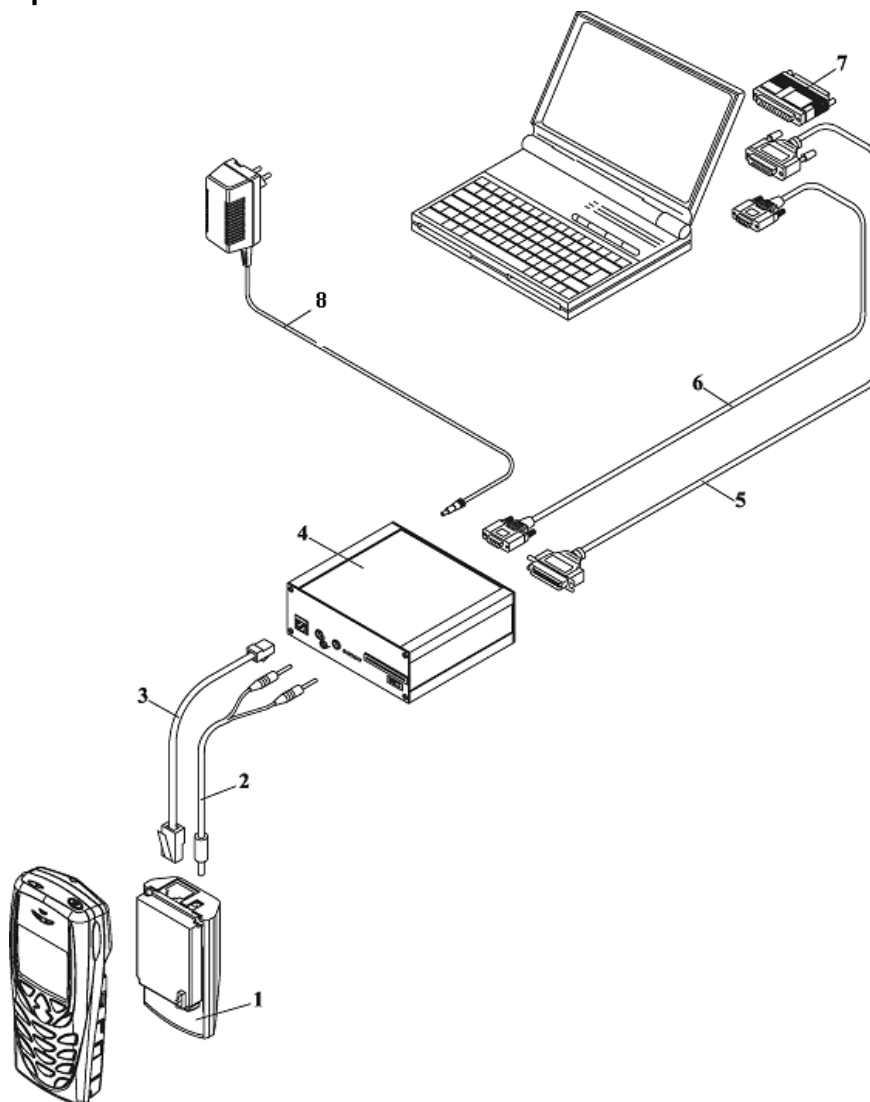
Item	Name	Type	Code
1	POS Flash loading adapter	FLA-39	0770490
2	Service cable	XCS-1	0730218
3	AC charger	ACP-8F	0680032
4	POS flash dongle	FLS-4S	0080543
	Software		

**Flashing, testing, and tuning with covers on (Setups 2a, 2b, 2c, 2d)**

Tightened performance specifications require more precise equipment and methods for testing and alignment. Manual tuning can't provide accurate results for RH-40 products, which means that this task has to be automated.

These setups are intended to be used with either Phoenix or Darium SW. With the Phoenix SW, it is possible to do manual testing and automated tuning. With Darium, it is possible to do automated testing and tuning.

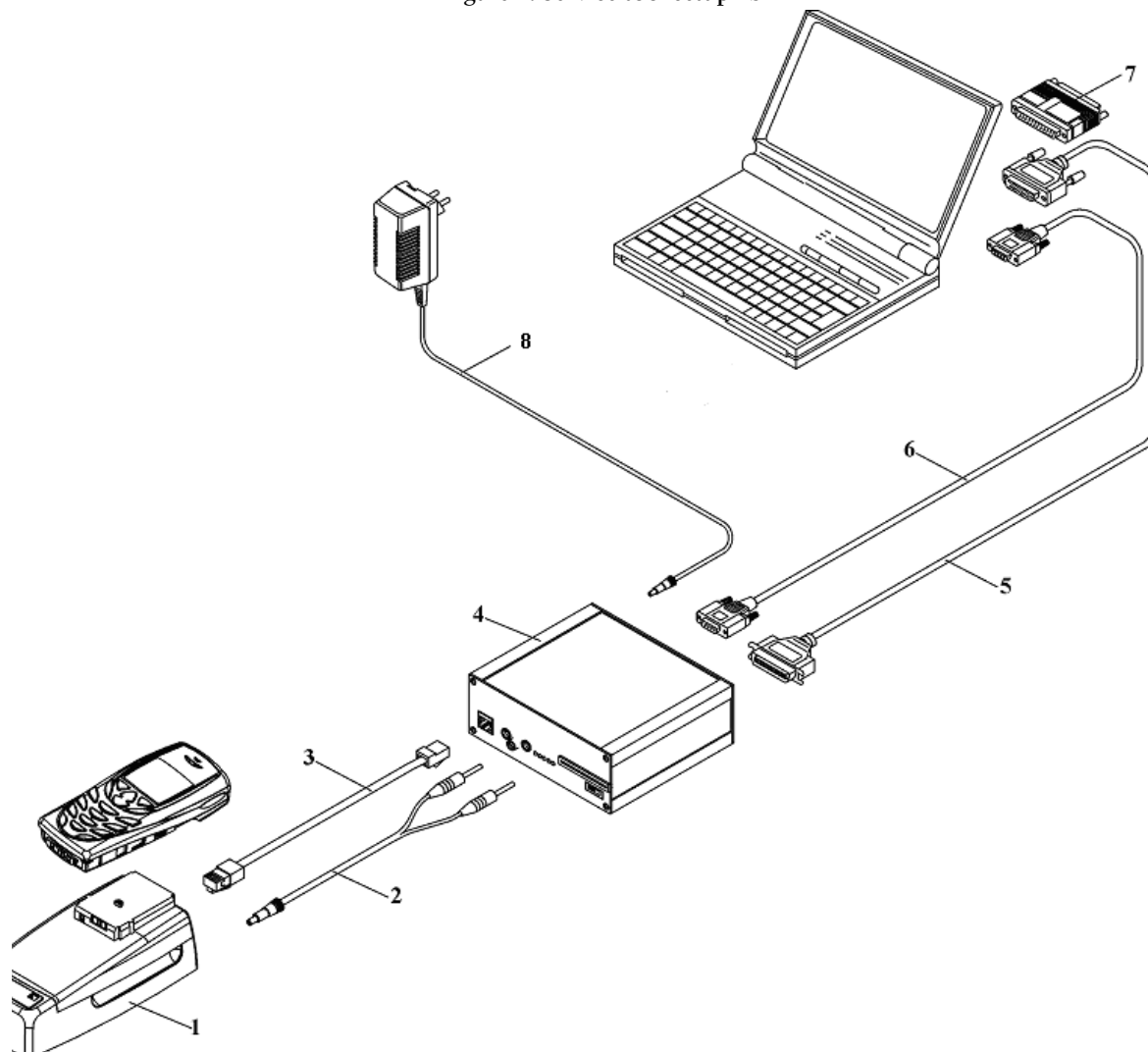
### Service Setup 2a



Item	Name	Type	Code
1	POS flash loading adapter	FLA-39	0770490
2	Power cable (included in FLA-14 sales pack)	FLC-2	0730185
3	Modular cable	XCS-4	0730178
4	Flash prommer box	FPS-8	0080321
5	Printer cable (included in FPS-8 sales pack)		0730029
6	D9-D9 cable (included in FPS-8 sales pack)		0730090
7	Software protection key	PKD-1	0750018
8	AC charger	ACP-8F	0680032

Service Setup 2b

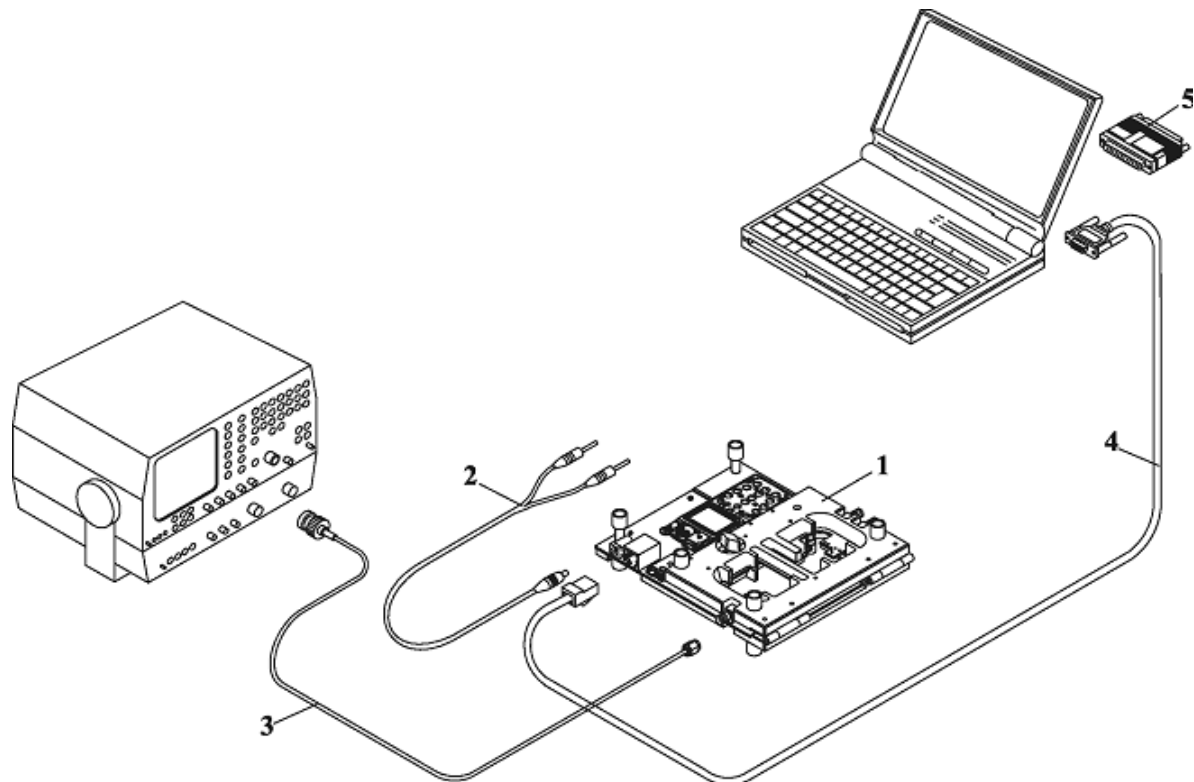
Figure 2: Service tool setup 2b



Item	Name	Type	Code
1	Docking station Docking station adapter	JBV-1 MJF-19	0770298 0770359
2	DC power cable	PCS-1	0730012
3	Modular cable	XCS-4	0730178
4	Flash prommer box	FPS-8	0080321
5	Printer cable (included in FPS-8 sales pack)		0730029
6	D9-D9 cable (included in FPS-8 sales pack)		0730090
7	Software protection key	PKD-1	0750018
8	AC charger	ACP-8F	0680032

## Service Setup 2c

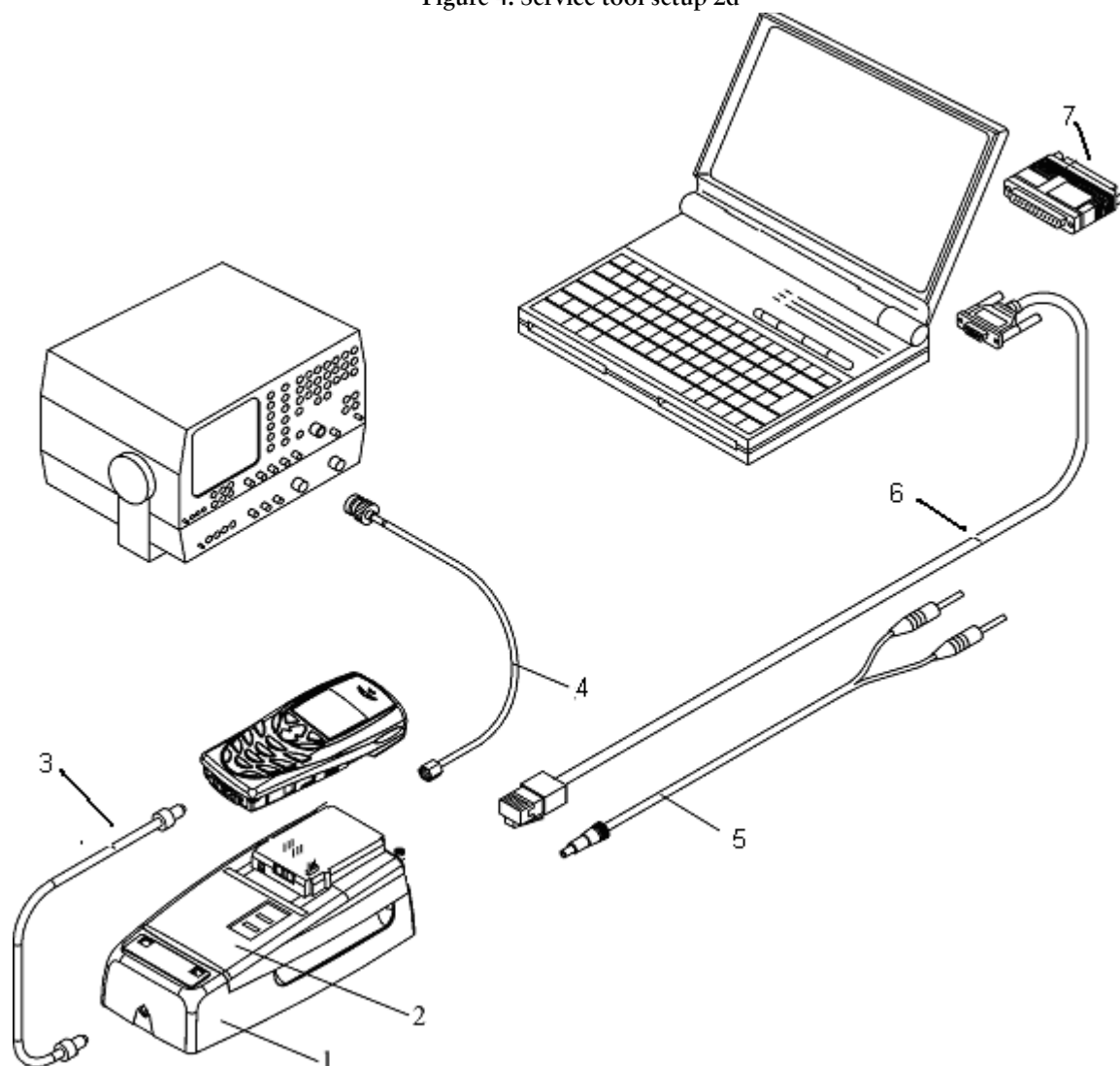
Figure 3: Service tool setup 2c



Item	Name	Type	Code
1	Module jig	MJS-18	0770299
2	DC power cable	PCS-1	0730012
3	RF antenna cable	XRF-1	0730085
4	Service MBUS cable	DAU-9S	0730108
5	Software protection key	PKD-1	0750018

## Service Setup 2d

Figure 4: Service tool setup 2d



Item	Name	Type	Code
1	Docking station	JBV-1	0770298
2	Docking station adapter	MJF-19	0770359
3	DC-DC cable	SCB-3	0730114
4	RF antenna cable	XRF-1	0730085
5	DC power cable	PCS-1	0730012
6	Service MBUS cable	DAU-9S	0730108
7	Software protection key	PKD-1	0750018

